

PS50

AIR DRIVE PLIER

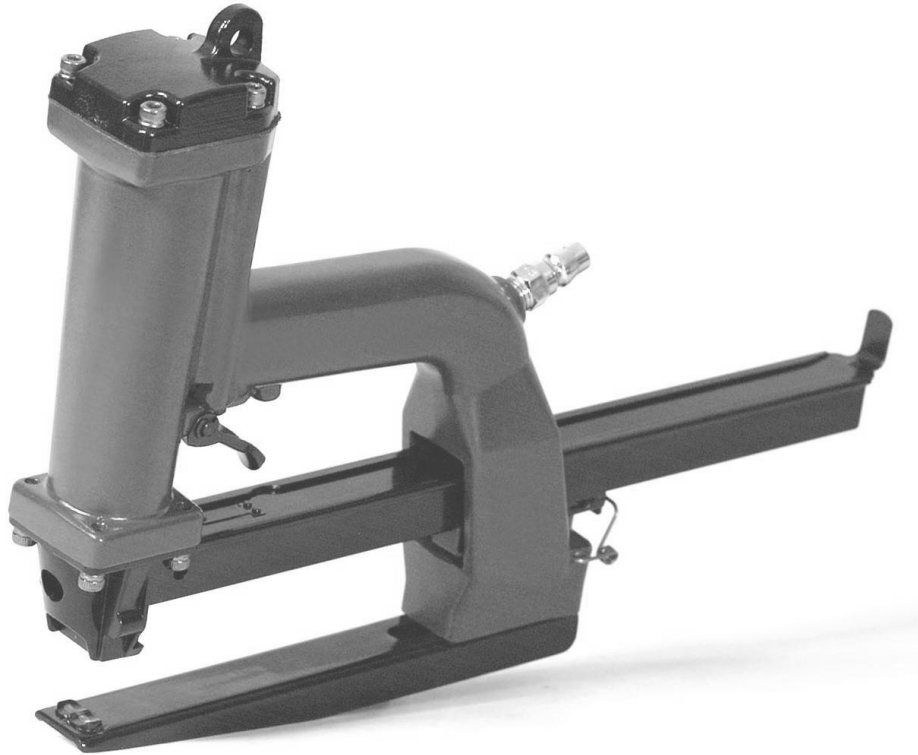

OPERATION and MAINTENANCE MANUAL

WARNING

BEFORE OPERATING THIS TOOL, ALL OPERATORS SHOULD STUDY THIS MANUAL, TO UNDERSTAND AND FOLLOW THE SAFETY WARNINGS AND INSTRUCTIONS. KEEP THESE INSTRUCTIONS WITH THE TOOL FOR FUTURE REFERENCE. IF YOU HAVE ANY QUESTIONS, CONTACT YOUR DISTRIBUTOR.

INTRODUCTION

The PS50 is a precision-built tool; designed for high speed, high volume stapling. These tools will deliver efficient, dependable service when used correctly and with care. As with any fine power tool, for best performance the manufacturer's instructions must be followed. Please study this manual before operating the tool and understand the safety warnings and cautions. The instructions on installation, operation and maintenance should be read carefully, and the manual kept for reference. NOTE: Additional safety measures may be required because of your particular application of the tool. Contact your distributor with any questions concerning the tool and its use.

INDEX

Safety Instructions	2
Air Supply and Connections	2
Loading Tool	3
Operation.....	3
Maintaining the Tool	3
Loading the PS50 Series Stapling Plier.....	5
Replace Driver Piston or Driver	8
Replace Anvil	9
Replace Driver Guide	10
Replace Pusher or Spring.....	11
Parts List	12
Exploded View of Tool.....	13

SAFETY INSTRUCTIONS

WARNING EYE PROTECTION which conforms to ANSI specifications and provides protection against flying particles both from the FRONT and SIDE should ALWAYS be worn by the operator and others in the work area when loading, operating or servicing this tool. Eye protection is required to guard against flying fasteners and debris, which could cause severe eye injury.



The employer and/or user must ensure that proper eye protection is worn. Eye protection equipment must conform to the requirements of the American National Standards Institute, ANSI Z87.1-1989 and provide both frontal and side protection. NOTE: Non-side shielded spectacles and face shields alone do not provide adequate protection.

WARNING **CAUTION: ADDITIONAL SAFETY PROTECTION** will be required in some environments. For example, the working area may include exposure to noise level which can lead to hearing damage. The employer and user must ensure that any necessary hearing protection is provided and used by the operator and others in the work area. Some environments will require the use of head protection equipment. When required, the employer and user must ensure that head protection conforming to ANSI Z89.1 1986 is used.

AIR SUPPLY AND CONNECTIONS

WARNING Do not use oxygen, combustible gases, or bottle gases as a power source for this tool as tool may explode, possibly causing injury.

WARNING Do not use supply sources which can potentially exceed 200 P.S.I.G as tool may burst possibly causing injury.

WARNING The connector on the tool must not hold pressure when air supply is disconnected. If a wrong fitting is used, the tool can remain charge with air after disconnecting and thus will be able to drive a fastener even after the air line is disconnected possibly causing injury.

WARNING Do not pull trigger or depress contact arm while connected to the air supply as the tool may cycle, possibly causing injury.

WARNING Always disconnect air supply:
1.) Before making adjustments;
2.) When servicing the tool;
3.) When Clearing a jam;
4.) When tool is not in use;
5.) When moving to a different work area, as accidental actuation may occur, possibly causing injury.

LOADING TOOL

WARNING When loading tool; 1.) Never place a hand or any part of body in fastener discharge area of tool; 2.) Never point tool at anyone; 3.) Do not pull the trigger or depress the trip as accidental actuation may occur, possibly causing injury.

OPERATION

WARNING Always handle the tool with care; 1.) Never engage in horseplay; 2.) Never pull the trigger unless nose is directed toward the work; 3.) Keep others a safe distance from the tool while tool is in operation as accidental actuation may occur, possibly causing injury.

WARNING The operator must not hold the trigger pulled on contact arm tools except during fastening operation as serious injury could result if the trip accidentally contacted someone or something, causing the tool to cycle.

WARNING Keep hands and body away from the discharge area of the tool. A contact arm tool may bounce from the recoil of driving a fastener and an unwanted second fastener may be driven possibly causing injury.

WARNING Check operation of the contact arm mechanism frequently. Do not use the tool if the arm is not working correctly as accidental driving of a fastener may result. Do not interfere with the proper operation of the contact arm mechanism.

WARNING Do not drive fasteners on top of other fasteners or with the tool at an overly steep angle as this may cause deflection of fasteners which could cause injury.

MAINTAINING THE TOOL

WARNING When working on air tools note the warnings in this manual and use extra care when evaluating problem tools.

AIR SUPPLY AND CONNECTIONS

OPERATING PRESSURE

The operating pressure of the PS50 series plier is 36 to 55 p.s.i (3.9kg/cm²). Tool wear will be greatly increased if excessive pressure is used.

WARNING

To prevent accidental firing, disconnection air supply:

- before making adjustments
- when servicing the tool
- when clearing jams
- when tool is not in use

SETTING THE CORRECT PRESSURE

The air equipments will vary, depending on the material to be stapled and the staple size. Do not use more air pressure than is required to drive the staple in the specific job. To determine best setting, start at low pressure and increase pressure until drive is satisfactory. Using excess pressure increases tool wear on the plier and wastes compressed air.

QUICK DISCONNECT FITTINGS

Install a free-flow connector plug on the nailer. Thread is 1/4" N.P.T.

Install a connector socket on the air hose. For best performance, fitting should have minimum inside dia. of .190"(4.8mm).

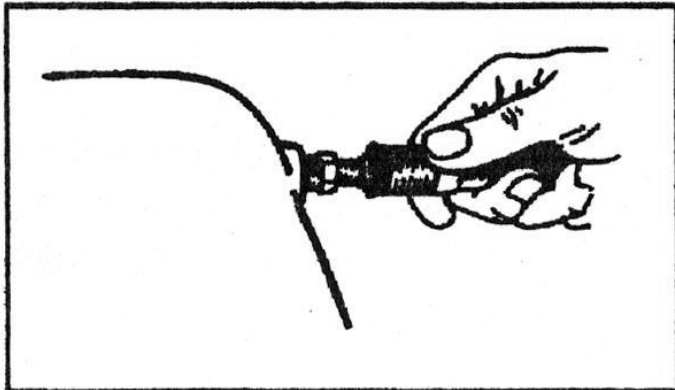

REGULATORS

Most air supply equipment will produce pressures that exceed the PS50's maximum operating pressure, 55 p.s.i (3.9kg/cm²). A pressure regulator is required to control the operating pressure. The flow capacity must be sufficient for the air usage at the installation.

HOSES

Air supply equipment should have a 85 p.s.i. (6.0 kg/cm²) working pressure rating (or 150 percent of the maximum pressure that could be produced in the air system.)

AIR CONSUMPTION

The PS50 requires 1.75 cubic feet per minute of free air to operate at the rate of 100 staples per minute, at 55 p.s.i.

Take the actual rate at which the plier will be run to determine the amount of air required. For instance, if your staple usage averages 50 staples per minute, you need 50% of the 7.75c.f.m. which is required for running at 100 staples per minute.

WARNING

Do not use oxygen or combustible gases as a power sources which can potentially exceed 200 P.S.I as tool may explode.

WARNING

NOTE: The air supply system must be capable of maintaining the required air pressure at the tool when it is operated at its highest cycle speed. Inadequate air supply will result in a loss of power and inconsistent driving after the first cycle when the tool is operated in high speed bursts.

Always attach a free-flow-connector plug to the plier. If a wrong fitting is used, the tool can remain charged with air after disconnecting, and thus will be able to cycle even after the air line is unplugged.

NOTE: Air compressors used to supply compressed air to this plier should comply with the requirements of the American National Standards Institute Standard B19.3-1972, Safety Standard for Compressors for Process Industries.

NOTE: Make sure air lines and fittings are clean before connecting.

LOADING THE PS50 SERIES STAPLING PLIER

WARNING

EYE PROTECTION which conforms to ANSI specifications and provides protection against flying particles both from the FRONT and SIDE should ALWAYS be worn by the operator and others in the work area when loading, operating or servicing this tool. Eye protection is Required to guard against flying fasteners and debris, which could cause severe eye injury.



The employer and/or user must ensure that proper eye protection is worn. Eye protection equipment must conform to the requirements of the American National Standards Institute, ANSI Z87.1-1989 and provide both frontal and side protection.

NOTE: Non-side shielded spectacles and face shields alone do not provide adequate protection.

WARNING

TO PREVENT ACCIDENTAL INJURIES:

- Never place a hand or any other part of the body in nail discharge area of tool while the air supply is connected.
- Never point the tool at anyone else.
- Never engage in horseplay.
- Never pull the trigger unless nose is directly towards the work.
- Always handle the tool with care.
- Do not pull the trigger or depress the trip mechanism while loading the tool.

MODEL PS-50 SERIES AIR DRIVE PLIERS

MODEL	ANVIL	STAPLES
PS50-10B-A	ANVIL A	SB103020 3/8" (9.5mm) 1/2" (12.7mm) 5/8" (15.8mm)
PS50-10B-B	ANVIL B	
PS50-10B-CL	ANVIL CL	
PS50-10B-CR	ANVIL CR	
PS50-5B-A	ANVIL A	SB5019 1/4" (6.3mm) 3/8" (9.5mm) 1/2" (12.7mm) 5/8" (15.8mm)
PS50-5B-B	ANVIL B	
PS50-5B-CL	ANVIL CL	
PS50-5B-CR	ANVIL CR	

1)Open the Magazine:

Pull cover back until locked by detent pin.

2)Load Staples:

Insert a stick of staple and push forward in the channel.

Insert a second stick of staples.

3)Close magazine:

Push the lock release tab(located at front of magazine cover) down and push the cover forward until its locked by the detent pin.

WARNING

Disconnect the air supply before making adjustments.

CAUTION: Do not attempt to operate this plier without material between the shuttle and clincher to avoid damaging the driver tip.

FILTERS

Dirt and water in the air supply is a major cause of wear in air tools. A filter will help to get best performance from this plier. The filter must have adequate flow capacity for the specific installation. The filter has to be kept clean to be effective in cleaning the air. Consult the filter manufacturer's instructions on proper maintenance. Clean and empty the filter as needed. A dirty and clogged filter will also cause a pressure drop, which can reduce the pliers performance.

LUBRICATION

Frequent but not excessive lubrication is required for best performance. Oil added through the air line connection will lubricate the internal parts. Use Mobil Velocite #10 oil or an equivalent. Do not use detergent oil or oil additives because the seals and bumpers in the tool may be attacked by the oil.

If an air line lubricator is used, add oil during use by squirting oil into the air fitting on the tool once or twice a day. Only a few drops at a time are required. Too much oil will collect inside the tool and will be noticeable in the exhaust.

For cold weather operation, near and below freezing, the oil and water present in the air line may freeze and prevent operation. We recommend the use of permanent antifreeze (ethylene glycol) as a cold weather lubricant. Note that some commercial air line drying liquids attack o-rings and seals – do not use these low temperature air dryers without checking compatibility.

MAINTAINING PS50 SERIES STAPLING PLIERS

WARNING When working on air tools, note the warnings in this manual, and use extra care when evaluating problem tools.

REPLACEMENT PARTS

Replacement parts are commended. Do not use modified parts or parts which will not give equivalent performance to the original equipment. When ordering replacement parts specify by part number.

WARNING Eye protection should be worn by the person operating or testing the plier, and by others in the work area.

ASSEMBLY PROCEDURES FOR SEALS

When repairing a plier make sure the internal parts are clean and freshly lubricated. Use Parker O-lube or equivalent on all “O” rings Coat each “O” rings with O-lube before assembling. Use a small amount of oil on all moving surfaces and pivots. After reassembly, add a few drops of Velocite #10 oil or equivalent, through the air line fitting before testing.

WARNING Disconnect the air supply supply before making adjustments, servicing the tool, clearing jams, or when tool is not in use.

TROUBLE SHOOTING

Shuttle Punches Through Board:

Pressure too high; staple leg too short.

Staple Leg Buckles And Flattens Against Work Surface:

Staple Leg too long, shuttle not down against work due to worn shuttle piston o-ring.

Driver Punches Through Board:

Worn driver piston bumper.

Staple Ejects From Nose Before Shuttle Contacts Work Surface:

Worn upper driver piston o-ring; excessive air pressure.

Staple Ejects From Rear Opening In Shuttle:

Worn driver piston o-ring.

Air Leakage Through Exhaust Port:

Worn upper driver piston o-ring; worn upper shuttle piston o-ring; worn valve stem seat.

Air Leakage Through Nose Piece:

Worn lower driver piston o-ring; worn shuttle piston o-ring.

Staples Tumbling In Staple Channel:

Feed springs overstressed; feed springs broken; pusher binding on magazine core; dirt inside magazine; excessive air pressure.

CLEANING JAMS:

Do not attempt to clear jammed staples by firing the tool to clear jam:

1. Disconnect Air supply.
2. Pull back top guide assembly and staples.
3. Pull down shuttle.
4. Remove jammed staple either from opening at the rear of shuttle or from drive track behind the magazine assembly.

To clear jam caused by tumbled staple or if jam can not be cleared as outlined above:

1. Be sure air supply is disconnected and top guide is pulled back.
2. Remove staples.
3. Snap magazine spring off magazine back.
4. Lift rear of magazine up and pull magazine back.
5. Remove jammed staple.
6. Slide magazine forward, aligning locating pins with holes in guide.
7. Push rear of magazine; do so with pin in magazine, block engages hole in frame.
8. Wedge magazine spring back onto magazine block.

***Special maintenance instructions:**

These are threaded parts that have been assembled with a plastic thread locking compound. They should be replaced in a Bostitch service center. However, if they must be replaced in the field, they may be separated by heating parts to approximately 450°F when the compound becomes plastic. Clean parts thoroughly. Degrease threads with Loctite solvent #75559, apply Loctite grade 277, and assemble. Allow 1/2 – 1 hour for sealant to cure at room temperature.

NOTE: The work opening between the shuttle and the clincher can be varied for special applications. The opening should never be increased to more than 31/32 (24.6mm) maximum for Standard Pointed, and Mattress Blade Pliers; and 27/32 (21.4mm) maximum for "C" Blade Pliers. It may be reduced by removing the clincher spacer between the clincher and the frame. If the spacer is removed be sure to check the length of the clincher mounting screws. Be sure they do not hit the magazine when they are replaced. Cut the screws off as needed, or use shorter screws.

Be sure all screws and nuts are checked periodically to keep them tight.

Observe caution against stripping threads when tightening fasteners.

A periodic check should be made of the bumpers. A Worn bumper should be replaced before damage occurs to related parts. To check, disconnect the air supply remove cap and piston. Check bumpers for wear and replace if necessary.

REPLACE DRIVER PISTON OR DRIVER

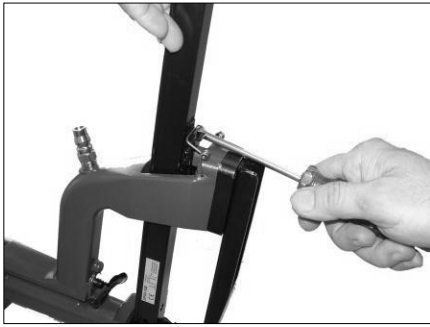

Release *Magazine Unit(024)*.



Release *Screw(501)* and take away *Cap(001)*, *Packing(002)*, and *Bumper(003)*.



Pull out *Cylinder Unit(007)*.



Release *C-ring(502)*.



Take away *Driver Piston(004)* and *Driver(006)*.

REPLACE ANVIL



Release the two *Screw (512,514)* and take away *Anvil (029)*.



Assemble the new *Anvil (029)* and *Screws (512,514)*.



Insert single staple into *Driver Guide(016)*, leaving points protruding.



Pull *Driver Guide(016)* down, until staple points contact *Anvil(029)*.



Align *Anvil(029)* with staple points by turning *Screw(506)*.

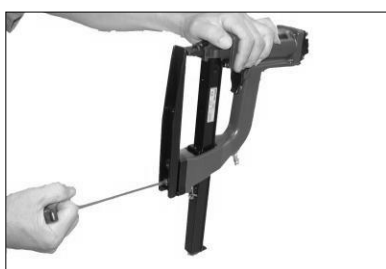

When *Anvil(029)* is properly aligned, tighten pivot *Screw(521)* first, then tighten retaining *Screw(514)*.

REPLACE DRIVER GUIDE

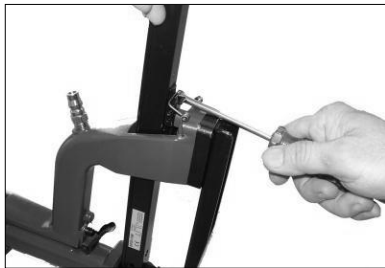

Release Magazine Unit(024).



Release Screws(501) and take away Cap(001), Packing(002) and Bumper(003).



Pull out Cylinder Unit(007).



Heat Screws(520).

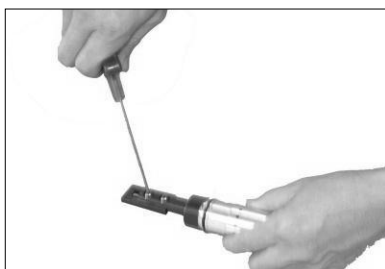

Release Screws(520) and take away Driver Guide(016).

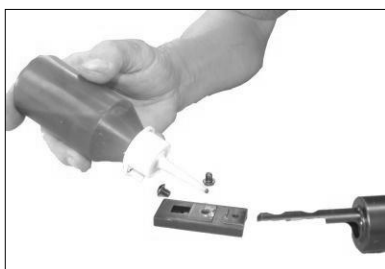

Reassemble New Driver Guide (016) and Screws(520).
NOTE:Use Locktite solvent #75559, apply Locktite grade 277.

REPLACE PUSHER OR SPRING

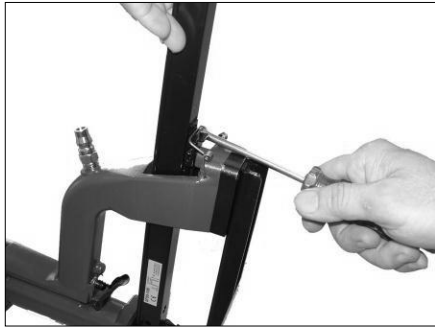

Release *Magazine Unit(024)*.



Push *Cover Unit(018)* forward and take away *Cover Unit(018)*.



Take away *Pusher(019)* from top hole on *Magazine(024)*.



Pull up and take away *Block(028)* from *Magazine(024)*.



Separate *Springs(022)* and *Block(028)* by taking away *Rod(025)*.