

EVERWIN

TOUGHER FASTER SMARTER

Pneumatic Corrugated Nailer

CFN-15S

OPERATIONS and MAINTENANCE MANUAL



! WARNING:

BEFORE OPERATING THIS TOOL, ALL OPERATORS SHOULD READ AND STUDY THIS MANUAL TO UNDERSTAND AND FOLLOW THE SAFETY WARNINGS AND INSTRUCTIONS. KEEP THESE INSTRUCTIONS WITH THE TOOL FOR FUTURE REFERENCE.

CE UK
CA

REV February, 17, 2023

The tool is designed for high-speed and high-volume fastening. This tool delivers efficient and dependable service when used correctly with care. As with any fine power tool, the manufacturer's instructions must be followed for best performance.

Please study this manual before operating the tool and understand the safety warnings and cautions. The instructions on installation, operation, and maintenance should be read carefully, and the manuals kept available for reference.

NOTE

Additional safety measures may be required because of your particular application of the tool. Contact your EVERWIN representative or distributor with any questions concerning the tool and its use.

Everwin Pneumatic Corp.,
No.7, Wugong 7th Road, Wufeng District, Taichung City, 413, Taiwan

INDEX

1-YEAR LIMITED WARRANTY	3
CE DECLARATION OF CONFORMITY	4
SAFETY INSTRUCTIONS	5
GENERAL SAFETY INSTRUCTION	7
SPECIFICATIONS AND TECHNICAL DATA	9
OPERATION : TRIGGER SELECTION	10
OPERATION : AIR SUPPLY AND CONNECTIONS (fittings, hoses, filters, air consumption, regulators, supply source)	11
OPERATION : LUBRICATION	12
OPERATION : FASTENER LOADING	13
OPERATION : TOOL OPERATION SYSTEM	14
OPERATION : TOOL OPERATION CHECK	15
OPERATION : TOOL-SPECIFIC FEATURES	16
MAINTAINING THE PNEUMATIC TOOL	17
TROUBLESHOOTING / REPAIRS	18

(U.S. and Canada Only)

EVERWIN products are designed and manufactured to the highest standards of both material and workmanship. EVERWIN warrants responsibility to the original retail purchaser that the product purchased was free from defect in material and workmanship, and agrees to repair or replace at EVERWIN's option any defective EVERWIN pneumatic stapler or nailer for a period of one year, subject to the exclusions and limitations described hereunder. To honor a warranty claim, EVERWIN and its authorized distributors need proof of purchase, may request the damaged tool, the serial number of the damaged tool, photos/videos of the defect for test and evaluation to determine whether the damaged tool is within warranty conditions; purchasers' cooperation in this regard will expedite the claim process and help EVERWIN's continuous efforts in quality improvement.

THIS WARRANTY IS IN LIEU OF ALL OTHER WARRANTIES, EXPRESS OR IMPLIED, INCLUDING BUT NOT LIMITED TO THE IMPLIED WARRANTIES OF MERCHANTABILITY OR FITNESS FOR A PARTICULAR PURPOSE. EVERWIN SHALL NOT BE LIABLE FOR ANY INCIDENTAL OR CONSEQUENTIAL DAMAGES.

WARRANTY EXCLUSIONS

The following warranty exclusions apply :

Normal wear parts are not covered by this warranty. Examples of normal wear parts include; O-rings and seals, driver blades, bumpers, pistons and piston rings.

Failure due to normal wear, neglect, abuse, misuse, misapplication, accidents, over-pressure usage, improper storage, shipping damages, improper maintenance, operation not within the operation manual's specification etc. are not covered by this warranty.

Labor charges, loss, repairs from improper maintenance and/or usage of non-EVERWIN parts are not covered by this warranty.

This warranty does not apply to production or industrial tools as defined by EVERWIN; industrial or production tools are covered on the following grounds.

GROUND FOR INDUSTRIAL / PRODUCTION TOOL COVERAGE

For high production industrial tools, coverage is limited to 90 days due to high volume usage; warranty on production tools cannot be guaranteed due to unpredictable circumstances. Tools are subjected to abuse such as hammering or usage of adjustment tools, especially true in loan tool programs. Upon receiving a report, EVERWIN and its authorized distributor may request the damaged tool, serial number of the damaged tool (as a gauge for the tool's age), and photos/videos of the defect for test and evaluation to find root causes. EVERWIN's analyst will judge the issuance of defective parts and will.

NOTE

All warranty services will be carried out by EVERWIN authorized repair centers, please contact: **sales@everwinpneumatic.com** for the location most convenient for you.

CE Declaration of conformity**ENGLISH**

EVERWIN PNEUMATIC CORP. declares that the product as described in attached documentation is in conformity with the Machinery Directive 2006/42/EC and the European standard EN ISO 11148-13:2018.

CE Dichiarazione di conformità**ITALIANO**

EVERWIN PNEUMATIC CORP. dichiara, assumendo la piena responsabilità, che questa fissatrice è conforme alla Direttive Europee 2006/42/EC e alla norma armonizzata EN ISO 11148-13:2018.

CE Konformitätserklärung**DEUTSCH**

EVERWIN PNEUMATIC CORP. erklärt hiermit in alleiniger Verantwortung das dieses Gerät übereinstimmt mit den Europäischen Richtlinien 2006/42/EC und den Europäischen Norm EN ISO 11148-13:2018.

CE Déclaration de conformité**FRANCAIS**

EVERWIN PNEUMATIC CORP. déclare et prend sur soi toute la responsabilité de cette déclaration, que le produit est en conformité avec les Directives Européennes 2006/42/EC et avec la norme harmonisée EN ISO 11148-13:2018.

CE konformiteitsverklaring**NEDERLANDS**

EVERWIN PNEUMATIC CORP. verklaart hierbij onder eigen verantwoording dat deze machine in overeenstemming is met de Europese Richtlijnen 2006/42/EC en de Europese norm EN ISO 11148-13:2018.

CE Declaracion de conformidad**ESPAÑOL**

EVERWIN PNEUMATIC CORP. declaramos bajo nuestra sola responsabilidad que este producto está en conformidad con las Directivas Europeas 2006/42/EC y con la normativa EN ISO 11148-13:2018.

Overensstemmelseserklæring / CE Deklaration**DANSK**

EVERWIN PNEUMATIC CORP. erklærer herved, at produktet er i overensstemmelse med nedenstående normer eller normative dokumenter 2006/42/EC i henhold til bestemmelserne i EU's direktiv EN ISO 11148-13:2018.

Överstämmelesförklaring / CE Deklaration**SVENSK**

EVERWIN PNEUMATIC CORP. förklarar härmed att produkten överensstämmer med följande normer och direktiv 2006/42/EC och SS-EN ISO 11148-13:2018.

SAMSVARERKLÆRING / CE Deklaration**NORSK**

EVERWIN PNEUMATIC CORP. erklærer herved at produktet er i samsvar med følgende normer og direktiv 2006/42 EC og NS-EN ISO 11148-13:2018.

Todistus CE standardin mukaisuudesta**FINSK**

EVERWIN PNEUMATIC CORP. vakuuttaa täten tuotteen vastaavan seuraavia standardeja ja direktiivejä: 2006/42/EC ja EN ISO 11148-13:2018.

Deklaracja zgodności CE**POLSKIE**

EVERWIN PNEUMATIC CORP. oświadcza, że produkty opisane w załączonej dokumentacji spełniają wymogi Dyrektywy Maszynowej 2006/42/EC oraz Europejskiej normy EN ISO 11148-13:2018.

Machine Type : CFN-15S

Machine Name : Pneumatic Fastener Driving Tool

Place of Issue : No. 7, Wugong 7th Rd., Wufeng Dist., Taichung City 41353, Taiwan.

Date of Issue : February, 17, 2023

Signature of Issuer :



Hung-Ming Chuang
General Manager



TO AVOID SEVERE PERSONAL INJURY OR PROPERTY DAMAGE

Before operating this tool, all operators should read and study this manual to understand and follow the safety warnings and instructions. Failure to follow warnings could result in death or serious injury. Keep these instructions with the tool for future reference.



Eye Protection

Which conforms to ANSI/ CE specifications and provides protection against flying particles both from the FRONT and SIDE should ALWAYS be worn by the operator and others in the work area when connecting to air supply, loading, operating, or servicing this tool. Eye protection is required to guard against flying fasteners and debris, which could cause severe eye injury. The employer and/or user must ensure that proper eye protection is worn. Eye protection equipment must conform to the requirements of the ANSI Z87.1 and 89/686/EEC, and provide both frontal and side protection.

NOTE

Non-side shielded spectacles and face shields alone do not provide adequate protection.



CAUTION

Additional Safety Protection is required in some environments. For example, the working area may include exposure to noise level which can lead to hearing damage. The employer and user must ensure that any necessary hearing protection is provided and used by the operator and others in the work area. Some environments will require the use of head protection equipment. When required, the employer and user must ensure that head protection conforming to ANSI Z89.1/ CE is used.



AIR SUPPLY AND CONNECTIONS



Do not use oxygen, combustible gases, or bottled gases as a power source for this tool as tool may explode possibly causing injury.



Do not use supply sources which can potentially exceed 14bar (200 PSI) as the tool may burst, possibly causing injury.



The connector on the tool must not hold pressure when air supply is disconnected. If a wrong fitting is used, the tool can remain charged with air after disconnecting and thus will be able to drive a fastener even after the air line is disconnected, possibly causing injury. Do not pull trigger or depress contact arm while connected to the air supply as the tool may cycle, possibly causing injury.

Always disconnect air supply: 1.) Before making adjustments; 2.) When servicing the tool; 3.) When clearing a jam; 4.) When tool is not in use; 5.) When moving to a different work area; otherwise, accidental actuation may occur, possibly causing injury.



FASTENER LOADING

When loading the tool: 1.) Never place a hand or any part of body in the fastener discharge area of the tool; 2.) Never point the tool at anyone; 3.) Do not pull the trigger or depress the trip as accidental actuation may occur, causing injury.



OPERATION

Always handle the tool with care: 1.) Never engage in horseplay; 2.) Only pull the trigger when the nose is directed toward the work piece; 3.) Keep a safe distance from other while the tool while tool is in operation as accidental actuation may occur, causing injury.

The operator must not hold the trigger or press on contact arm except during fastening operation as serious injury can result if the trip accidentally contacts someone or something, causing the tool to cycle.



Keep hands and body away from the discharge area of the tool. A contact arm tool may bounce from the recoil of driving a fastener and an unwanted second fastener may be driven, possibly causing injury.

Check operation of the contact-arm mechanism frequently. Do not use the tool if the arm is not working correctly as accidental driving of a fastener may result. Do not interfere with the proper operation of the contact-arm mechanism.

Do not drive fasteners on top of other fasteners or with the tool at an overly steep angle as this may cause deflection of fasteners which could cause injury.

Do not drive fasteners close to the edge of the work piece as the wood may split, allowing the fastener to be deflected causing injury.

This tool has either a selective actuation for contact actuation or sequential contact actuation, or is solely contact actuation, or solely contact actuation. Its intended uses are for production applications such as pallets, furniture, manufactured housing, upholstery, and sheathing.

When using this tool in selective actuation mode, always ensure it is in the correct actuation setting. Do not use this tool in contact actuation for applications such as closing boxes or crates and fitting transportation safety systems on trailers and lorries.

Be careful when changing from one driving location to another.



MAINTAINING THE TOOL

When working on air tools, note the warnings in this manual and use extra care when evaluating tools with problems.

Repetitive Motions Hazards

- When using a tool for long periods, the operator may experience discomfort in the hands, arms, shoulders, neck, or other parts of the body.
- While using a tool, the operator should adopt a suitable but ergonomic posture. Maintain secure footing and avoid awkward or off-balanced postures.
- If the operator experiences symptoms such as persistent or recurring discomfort, pain, throbbing, aching, tingling, numbness, burning sensation, or stiffness, do not ignore these warning signs. The operator should consult a qualified health professional regarding overall activities.

Accessory and Consumable Hazards

- Disconnect the energy supply to the tool, such as air, gas, or battery, before changing /replacing accessories such as workpiece contact, or making any adjustments.
 - Use only the sizes and types of accessories that are provided by EVERWIN PNEUMATIC CORP.
 - Use only lubricants recommended by EVERWIN PNEUMATIC CORP.
- slippery surfaces caused by use of the tool and also trip hazards caused by the airline hose.gripping force, the contact pressure force, the working direction, the adjustment of energy supply, the workpiece, the workpiece support.

Workplace Hazards

- Slips, trips, and falls are major causes of workplace injury. Be aware of slippery surfaces caused by use of the tool and also trip hazards caused by the airline hose.
- Proceed with additional care in unfamiliar surroundings. Hidden hazards may exist, such as electricity or other utility lines.
- This tool is not intended for use in potentially explosive atmospheres and is not insulated from coming into contact with electrical power.
- Make sure there are no electrical cables, gas pipes, etc. that could cause a hazard if damaged by use of the tool.

Dust and Exhaust Hazards

- If the tool is used in an area where there is static dust, it may disturb the dust and cause a hazard. Proceed with the following:
- Direct the exhaust to minimize disturbance of dust in a dust filled environment.
 - Where dust or exhaust hazards are created, the priority shall be to control them at the point of emission.

Noise Hazards

- The noise values reported in the operation manual are tool-related characteristic values and do not represent the noise generation at the point of use. Noise at the point of use will for example depend on the working environment, the workpiece, the workpiece support, and the number of driving operations.
- Unprotected exposure to high noise levels can cause permanent, disabling, hearing loss and other problems such as tinnitus (ringing, buzzing, whistling or humming in the ears).

- Appropriate controls to reduce the risk may include actions such as damping materials to prevent workpieces from "ringing".
- Use appropriate hearing protection.
- Operate and maintain the tool as recommended in these instructions, to prevent an unnecessary increase in noise levels.
- If the tool has a silencer, always ensure it is in place and in good working order when the tool is being operated.

Vibration Hazards

- The vibration emission value reported in the operation manual is a tool-related characteristic value and does not represent the influence to the hand-arm-system when using the tool. Any influence to the hand-arm-system when using the tool will for example depend on the gripping force, the contact pressure force, the working direction, the adjustment of energy supply, the workpiece, the workpiece support.
- Exposure to vibration can cause disabling damage to the nerves and blood supply of the hands and arms.
- Wear warm clothing when working in cold conditions, keep your hands warm and dry.
- If you experience numbness, tingling, pain, or whitening of the skin in your fingers or hands, seek medical advice from a qualified occupational health professional regarding overall activities.
- Operate and maintain the tool as recommended in these instructions, to prevent an unnecessary increase in vibration levels.
- Hold the tool with a light, but safe, grip because the risk from vibration is generally greater when the grip force is higher.

Additional Safety Instructions for Pneumatic tools

- Compressed air can cause severe injury.
- Always shut off air supply and disconnect tool from air supply when not in use.
- Always disconnect the tool from the compressed air supply before changing accessories, making adjustments and /or repairs, when moving away from an operating area to a different area.
- Keep fingers away from trigger when not operating the tool and when moving from one operating position to another.
- Never direct compressed air at yourself or anyone else.
- Whipping hoses can cause severe injury. Always check for damaged or loose hoses or fittings.
- Never carry a pneumatic tool by its hose.
- Never drag a pneumatic tool by its hose.
- When using pneumatic tools, do not exceed the maximum operating pressure ps max.
- Pneumatic tools should only be powered by compressed air at the lowest pressure required for the work process to reduce noise and vibration and minimize wear.
- Using oxygen or combustible gases for operating pneumatic tools creates a fire and explosion hazard.
- Be careful when using pneumatic tools as the tool could become cold, affecting grip and control.

SPECIFICATIONS

Model	CFN-15S
Height	270mm (10.6")
Width	92mm (3.6")
Length	320mm (12.6")
Weight	2.4kg (5.28lbs)
Loading Capacity	80
Air Consumption at 6.3 bar (90PSI) Pressure	0.71 liter/second (1.5 cfm)

FASTENER SPECIFICATIONS

Model	CFN-15S
Length	9, 12, 15mm (3/8", 1/2", 5/8")
Crown Width	25.4mm (1")
Thickness	2.2mm (0.086")
Type	Senco SC2

TOOL AIR FITTING

This tool uses a 1/4"-19 P.T & 1/4"-18 N.P.T male plug. The inside diameter should be 5 mm (0.200") or larger. The fitting must be capable of discharging tool air pressure when disconnected from the air supply.

OPERATING PRESSURE

4.5 to 7.5bar (65 to 110PSI). Select the operating pressure within this range for best fastener performance. Do not exceed this recommended operating pressure.

AIR CONSUMPTION

Tool air consumption : 0.71 liter/second (1.5 cfm) of free air to operate at the rate of 100 nails per minute, at 6.3 bar (90 PSI).

NOISE

A-weighted single-event sound power level LWA,1sd: 98.38 dBA

A-weighted single-event emission sound pressure level at work station LPA 1sd: 85.38 dBA

These values are determined and documented in accordance to EN12549.

VIBRATION

Vibration / Uncertainty: 3.15 / N/A m/s²

These values are determined and documented in accordance to ISO 8662-11.

This value is a tool-related characteristic value and does not represent the influence to the hand-arm-system when using the tool. An influence to the hand-arm-system when using the tool will, for example, depend on the gripping force, the contact pressure force, the working direction, the adjustment of mains supply and the workpiece support.

Refer to Operation Instructions and warnings pages before proceeding to use this tool.
 There are two available systems in these tools :

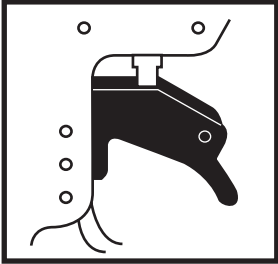
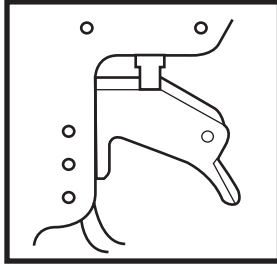
1. Contact Trip	2. Sequential Trip
Identified by Black Trigger	Identified by Grey Trigger
	

1. Contact Trip

(available system on : CFN-15S-CT)

The common operating procedure on “Contact Trip” tools is for the operator to contact the workpiece to actuate the trip mechanism while keeping the trigger pulled, thus driving a fastener each time the workpiece is contacted. This will allow rapid fastener placement on many jobs, such as sheathing, decking, and pallet assembly. All pneumatic tools are subject to recoil when driving fasteners. The tool may bounce, releasing the trip, and if unintentionally allowed to recontact the work surface with the trigger still actuated (finger still holding trigger pulled) an unwanted second fastener will be driven.

2. Sequential Trip

(available system on : CFN-15S-ST)

The Sequential Trip requires the operator to hold the tool against the work before pulling the trigger. This makes accurate fastener placement easier, for instance on framing, toe nailing, and crating applications. The Sequential Trip allows exact fastener location without the possibility of driving a second fastener on recoil, as described under “Contact Trip”. The Sequential Trip Tool has a positive safety advantage because it will not accidentally drive a fastener if the tool is contacted against the workpiece – or anything else – while the operator is holding the trigger pulled.



DO NOT USE OXYGEN, COMBUSTIBLE GASES, OR BOTTLED GASES AS A POWER SOURCE FOR THIS TOOL AS TOOL MAY EXPLODE, POSSIBLY CAUSING INJURY.

FITTINGS

Install a male plug on the tool which is free flowing and which will release air pressure from the tool when disconnected from the supply source.

HOSES

Air hoses should have a minimum of 10.6 bar (150 PSI) working pressure rating or 150 percent of the maximum pressure that could be produced in the air system. The supply hose should contain a fitting that will provide “quick disconnecting” from the male plug on the tool.

SUPPLY SOURCE

Use only clean, regulated compressed air as a power source for this tool. Never use oxygen, combustible gases, or bottled gases as a power source for this tool as the tool may explode.

REGULATOR

A pressure regulator with an operating pressure of 0 ~ 8.79 bar (0 ~ 125 PSI) is required to control the operating pressure for safe operation of this tool. Do not connect this tool to air pressure which can potentially exceed 14 bar (200 PSI) as tool may fracture or burst, causing injury.

OPERATING PRESSURE

Do not exceed recommended maximum operating pressure as tool wear will be greatly increased. The air supply must be capable of maintaining the operating pressure at the tool. Pressure drops in the air supply can reduce the tool's driving power. Refer to “Tool Specifications” for setting the correct operating pressure for the tool.

FILTER

Dirt and water in the air supply are major causes of wear in pneumatic tools. A filter will help to get the best performance and minimum wear from the tool. The filter must have adequate flow capacity for the specific installation. The filter has to be kept clean to be effective in providing clean compressed air to the tool.

Consult the manufacturer's instructions on proper maintenance of your filter. A dirty and/or clogged filter will cause a pressure drop which will reduce the tool's performance.

Frequent, but not excessive, lubrication is required for best performance. Air - tool oil added through the air line connection will lubricate the internal parts. Do not use detergent oil or additives as these lubricants will cause accelerated wear to the seals and bumpers in the tool, resulting in poor tool performance and frequent tool maintenance.

If no air line lubricator is used, add oil during use into the air fitting on the tool once or twice a day. Only a few drops of oil at a time is necessary. Too much oil will only collect inside the tool and will be noticeable in the exhaust cycle.

Cold Weather Operation

For cold weather operation, near and below freezing, the moisture in the air line may freeze and prevent tool operation. We recommend the use of permanent antifreeze (ethylene glycol) as a cold weather lubricant.

CAUTION

Do not store tools in a cold-weather environment to prevent frost or ice formation on the tools operating valves and mechanisms, which could cause tool failure. Test tool without fasteners prior to operations to ensure no malfunction on the tool due to ice formation.

NOTE

Some commercial air line drying liquids are harmful to O-Rings and seals – do not use these low temperature air dryers without checking compatibility.



EYE PROTECTION

Which conforms to ANSI/ CE specifications and provides protection against flying particles both from the FRONT and SIDE should ALWAYS be worn by the operator and others in the work area when connecting to air supply, loading, operating, or servicing this tool. Eye protection is required to guard against flying fasteners and debris, which could cause severe eye injury. The employer and/or user must ensure that proper eye protection is worn. Eye protection equipment must conform to the requirements of the ANSI Z87.1 and 89/686/EEC, and provide both frontal and side protection.

NOTE

Non-side shielded spectacles and face shields alone do not provide adequate protection.



TO PREVENT ACCIDENTAL INJURIES

- Never place a hand or any other part of the body in the discharge area of tool while the air supply is connected.
- Never point the tool at anyone else.
- Never engage in horseplay.
- Never pull the trigger unless the nose is directed at the workpiece.
- Always handle the tool with care.
- Do not pull the trigger or depress the trip mechanism while loading the tool.

Loading the Tool

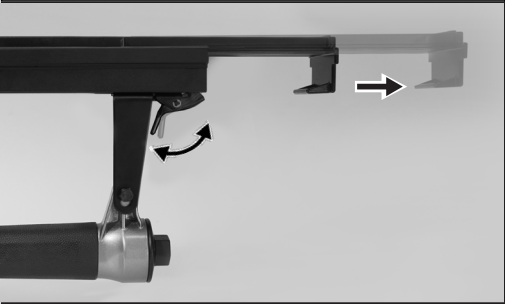
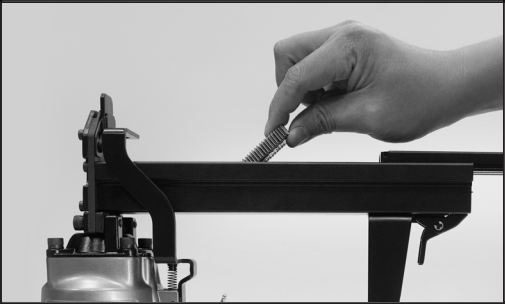
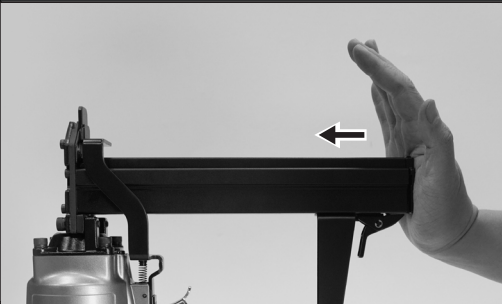
Open Magazine	Load Fasteners	Close Magazine
		
<ol style="list-style-type: none"> 1. Disconnect air source. 2. Rotate tool upside down and let magazine at upper side. 3. Pull Magazine Seat backward to fully opened. 	<ol style="list-style-type: none"> 1. Insert a stick fasteners into magazine. 2. Make sure the sharp point of fasteners are pointed upward and fasteners are not dirty or damaged. 	<ol style="list-style-type: none"> 1. Push Magazine Seat forward to close until the latch is fixed at correct position.



EYE PROTECTION

Which conforms to ANSI/ CE specifications and provides protection against flying particles both from the FRONT and SIDE should ALWAYS be worn by the operator and others in the work area when connecting to air supply, loading, operating, or servicing this tool. Eye protection is required to guard against flying fasteners and debris, which could cause severe eye injury. The employer and/or user must ensure that proper eye protection is worn. Eye protection equipment must conform to the requirements of the ANSI Z87.1 and 89/686/EEC, and provide both frontal and side protection.

NOTE

Non-side shielded spectacles and face shields alone do not provide adequate protection.



BEFORE HANDLING OR OPERATING THIS TOOL

- Read and understand the warnings contained in this manual.
- Refer to “tool specifications” in this manual to identify the operating system on your tool.

There are two available systems in these tools :

1. Contact Trip Operation

(available system on : CFN-15S-CT)

The CONTACT TRIP MODEL tool contains a contact trip that operates in conjunction with the trigger to drive a fastener. To operate the tool in this manner, hold the tool with the contact trip pointing towards but not touching the work surface. Pull the trigger and then tap the contact trip against the work surface using a bouncing motion. Each depression of the contact trip will cause a fastener to be driven.

WARNING

The operator must not hold the trigger on contact trip tools except during fastening operation, as serious injury could result if the trip accidentally contacts someone or something, causing the tool to cycle.

WARNING

Keep hands and body away from the discharge area of the tool. A contact trip tool may bounce from the recoil of driving a fastener and an unwanted second fastener may be driven, causing injury.

2. Sequential Trip Operation

(available system on : CFN-15S-ST)

The SEQUENTIAL TRIP MODEL contains a contact trip that operates in conjunction with the trigger to drive a fastener. To operate a sequential trip tool, first position the contact trip on the work surface WITHOUT PULLING THE TRIGGER. Depress the contact trip and then pull the trigger to drive a fastener. As long as the contact trip is contacting the work and is held depressed, the tool will drive a fastener each time the trigger is depressed. If the contact trip is allowed to leave the work surface, the sequence described above must be repeated to drive another fastener.

CAUTION

Remove all fasteners from tool before performing tool operation check.

1. Contact Trip Operation

a. With finger off the trigger, press the contact trip against the work surface.

a. The tool **MUST NOT** cycle.

b. Hold the tool off the work surface, and pull the trigger.

b. The tool **MUST NOT** cycle.

c. With the tool off the work surface, pull the trigger. Press the contact trip against the work surface.

c. The tool **MUST** cycle.

d. Without touching the trigger, press the contact trip against the work surface, then pull the trigger.

d. The tool **MUST** cycle.

2. Sequential Trip Operation

a. Press the contact trip against the work surface, without touching the trigger.

a. The tool **MUST NOT** cycle.

b. Hold the tool off the work surface, and pull the trigger.

b. The tool **MUST NOT** cycle.

Release the trigger. The trigger must return to the trigger stop on the frame.

c. Pull the trigger and press the contact trip against the work surface.

c. The tool **MUST NOT** cycle.

d. With finger off the trigger, press the contact trip against the work surface. Pull the trigger

d. The tool **MUST** cycle.



In addition to the other warnings contained in this manual observe the following for safe operation :

- Never use this tool in a manner that could cause a fastener to be directed toward the user or others in the work area.
- Do not use the tool as a hammer.
- Always carry the tool by the handle. Never carry the tool by the air hose.
- Do not carry this tool with the trigger depressed when not in use.
- Do not alter or modify this tool from the original design or function.
- Always be aware that misuse and improper handling of this tool can cause injury to yourself and others.
- Never clamp or tape the trigger or contact trip in an actuated position.
- Never leave a tool unattended with the air hose attached.
- Do not operate this tool if it does not contain a legible WARNING LABEL.
- Do not continue to use a tool that leaks air or does not function properly. Notify your distributor or representative if your tool continues to experience functional problems.

WARNING

ALWAYS disconnect air supply before performing following adjustment.

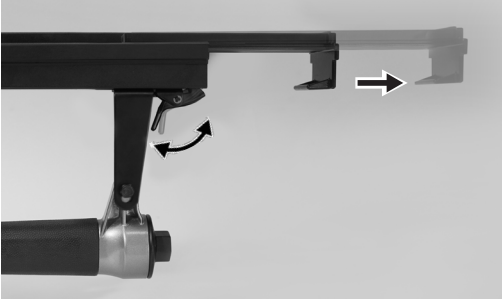
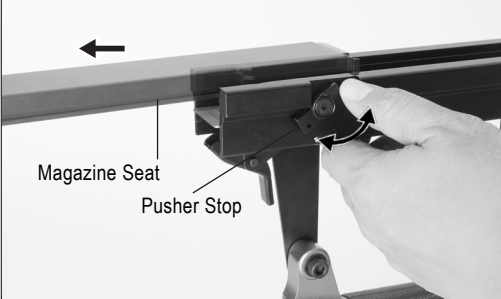
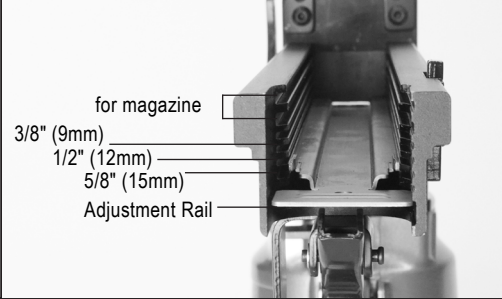
1. Fasteners Length Adjustment

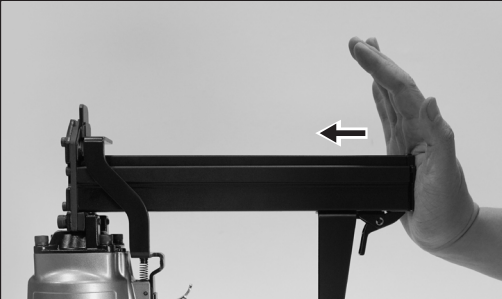
Open Magazine	Remove Magazine Seat	Identify Proper Rail Position
	 <p>Magazine Seat Pusher Stop</p>	 <p>for magazine 3/8" (9mm) 1/2" (12mm) 5/8" (15mm) Adjustment Rail</p>
<p>1. Disconnect air source. 2. Rotate tool upside down where magazine is at the top. 3. Depress the latch and slide Magazine open.</p>	<p>4. Turn pusher stop. 5. Remove Magazine Seat and set aside.</p>	<p>6. Identify Rail position according to fastener length. 7. Remove Adjustment Rail by sliding to the rear of the magazine.</p>
Install the Adjustment Rail	Load Fasteners	Close Magazine
 <p>Adjustment Rail</p>		
<p>8. Insert the Adjustment Rail into the correct channel. 9. Push the Adjustment Rail forward until it locks into position.</p>	<p>10. Load fasteners with points facing upwards.</p> <p>NOTE ALWAYS load fasteners with sharp end facing out of the tool.</p> <p>NOTE Check fastener manufacturers literature for proper orientation.</p>	<p>11. Reinstall the Magazine Seat. 12. Push the Magazine Seat forward until the latch is engaged.</p>

WARNING

When working on pneumatic tools, note the warnings in this manual and use extra care evaluating tools with problems. Disconnect the air supply and empty the magazine when inspecting or maintaining the tool.

REPLACEMENT PARTS

Use only genuine parts from the manufacturer or distributor. Do not use modified parts or parts which will not give equivalent performance to the original equipment. Tighten all screws. Keep contact arm moving smoothly.

ASSEMBLY PROCEDURE FOR SEALS

When repairing a tool, make sure the internal parts are clean and lubricated. Use O-Ring lubricant on all O-Rings. Coat each O-Ring with O-Ring lubricant before assembling. Use a small amount of oil on all moving surfaces and pivots. After reassembly add a few drops of Air Tool Lubricant through the air line fitting before testing.

AIR PRESSURE AND VOLUME

Air volume is as important as air pressure. The air volume supplied to the tool may be inadequate because of undersize fittings and hoses, or from the effects of dirt and water in the system. Restricted air flow will prevent the tool from receiving an adequate volume of air, even though the pressure reading is high. The results will be slow operation, misfeeds or reduced driving power. Before evaluating tool problems for these symptoms, trace the air supply from the tool to the supply source for restrictive connectors, swivel fittings, low points containing water and anything else that would prevent full volume flow of air to the tool.

DRIVER MAINTENANCE INSTRUCTIONS

Worn drivers can cause poor driving quality or loss of power:

Worn or chipped driving tips will affect the fastener drive, give symptoms of bent and incompletely driven fastener, and damaged fastener heads.

When there is a need, please contact a qualified service technician for this replacement.

The troubleshooting and / or repairs shall be carried out only by the authorized dealer / distributor or by other pneumatic tool specialists.

Jam-Clearing Procedure

WARNING

Always disconnect air supply before clearing a jammed fastener.

If a jam occurs on the CFN-15S-CT, CFN-15S-ST, follow this procedure :

1. Disconnect the tool from air source.
2. Open Magazine: Pull Magazine Seat backward by pushing magazine latch.
3. Remove jammed fasteners. If necessary, grab fasteners with pliers.
- 4 .After making sure all jammed fasteners are removed, push Magazine Seat to close.
5. Follow "Loading the Tool" paragraph to re-load fasteners.

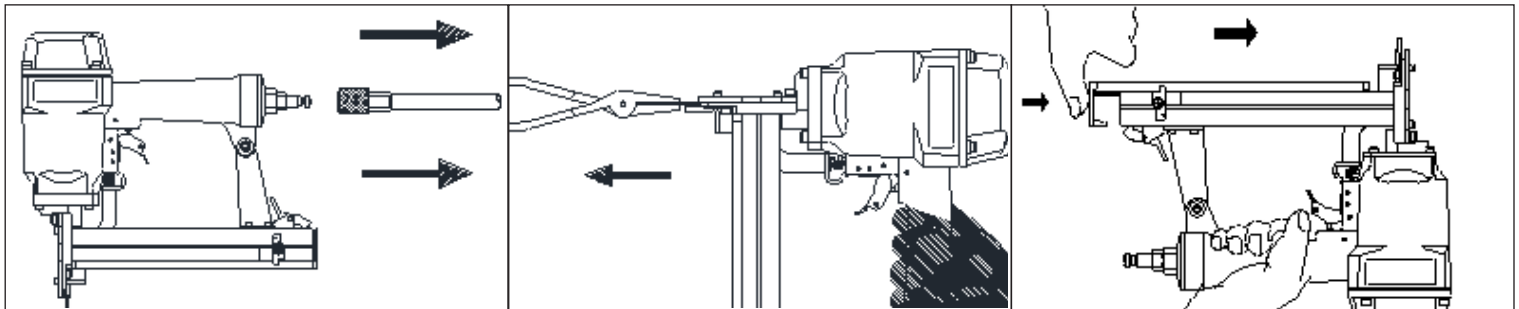

EVERWIN

TOUGHER FASTER SMARTER

Follow Us to Get More Information



@everwintaiwan



@everwin_official



Everwin Pneumatic



No.7, Wugong 7th Road, Wufeng District,
Taichung City, 413, Taiwan



TEL. : +886-4-2333-2999



FAX : +886-4-2333-0555



www.everwinpneumatic.com



sales@everwinpneumatic.com